

BURTON JAMES

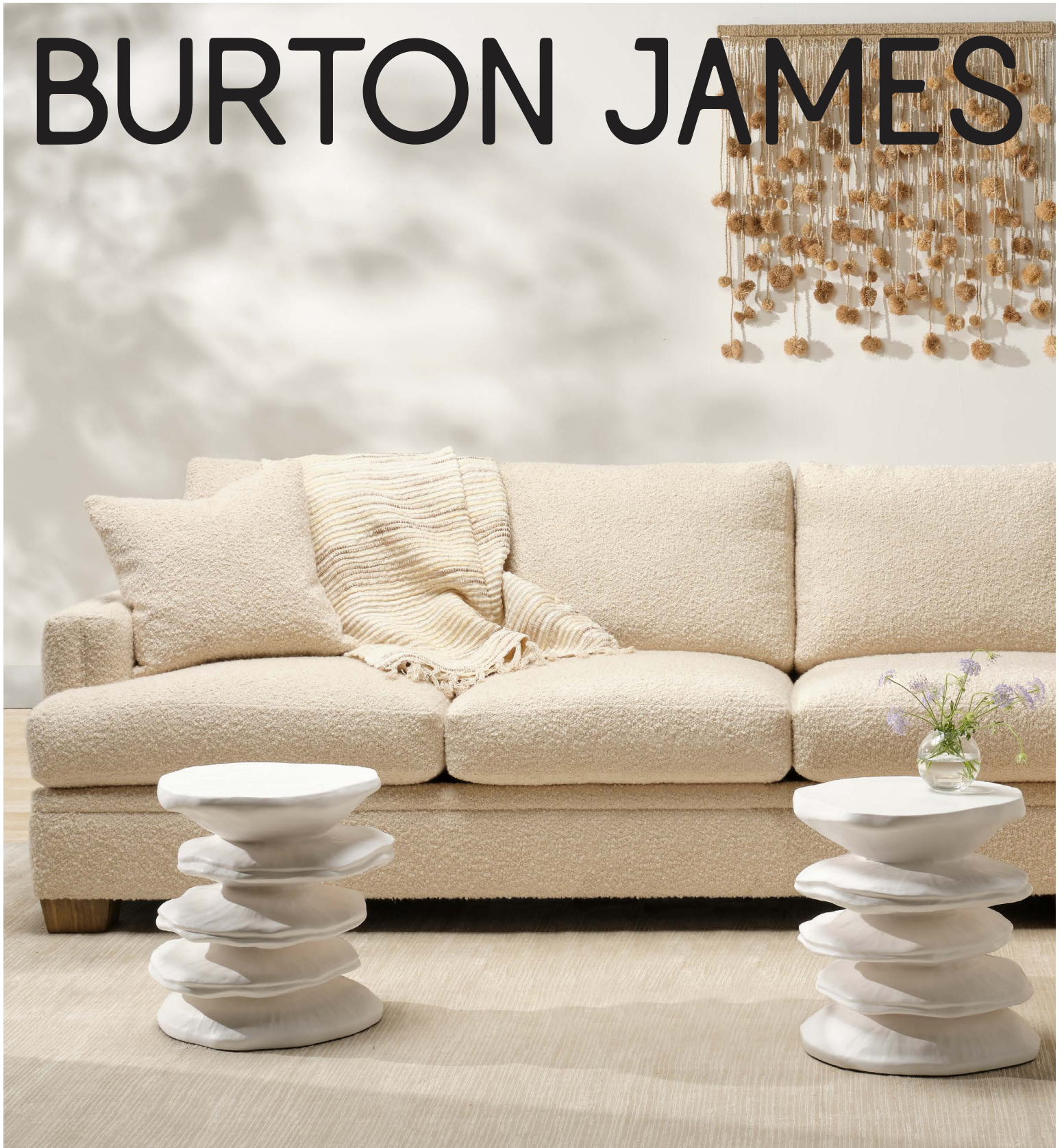

ALTERNATIVES

PERFECT COMFORT FOR EVERY STYLE

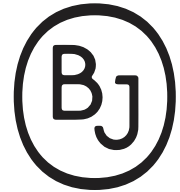

PERFECTLY STYLISH,
 PERFECTLY COMFORTABLE,
PERFECTLY
YOU

Our **ALTERNATIVES** program, widely acclaimed as our most popular program among designers, distinguishes itself by offering the widest array of configurations, along with the option to select your depth and height.

Featuring a selection of arm styles, base and leg options, and back and seat cushion styles, **ALTERNATIVES** offers you the ability to create the spaces you dream of.

For questions, more information, or to request a custom quote, contact your sales representative or visit BURTONJAMES.COM.



STANDARD FEATURES

- Cloud 9 Seat Cushions
- Blend Down Back Cushions
- 8 Gauge Sinuous Springs
- Solid Kiln-Dried Wood Frame
- All Pieces Available In:
 Overall Depths: 36", 38", and 40"
 Back Heights: 34", 36", and 38"
 Seat Cushions: 27"W
 - #10 chair cushion is 23"W
 - #22 small sofa cushion is 30"W

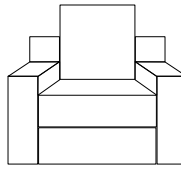
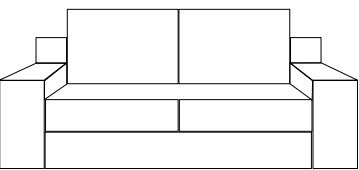
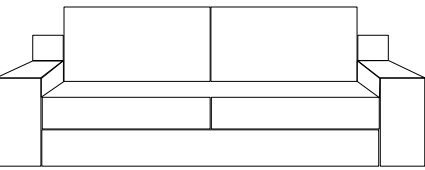
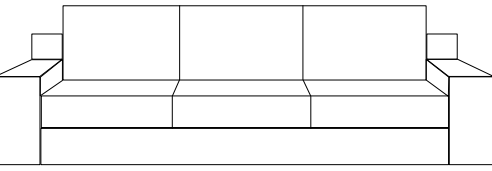
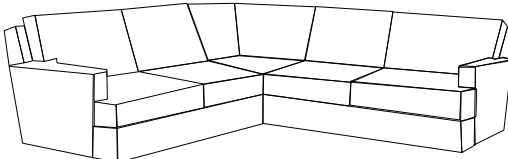

STEP 1: CHOOSE YOUR STYLE, DEPTH, AND HEIGHT

STYLE	OVERALL DEPTH	OVERALL HEIGHT
 <ul style="list-style-type: none"> <input type="checkbox"/> #10 - 23" Chair + Arms <input type="checkbox"/> Swivel Base (\$800 MSRP) 	<input type="checkbox"/> 36" (22" Seat Depth) <input type="checkbox"/> 38" (23" Seat Depth) <input type="checkbox"/> 40" (24" Seat Depth)	<input type="checkbox"/> 34" <input type="checkbox"/> 36" <input type="checkbox"/> 38"
 <ul style="list-style-type: none"> <input type="checkbox"/> #20 - 54" Loveseat + Arms 	<input type="checkbox"/> 36" (22" Seat Depth) <input type="checkbox"/> 38" (23" Seat Depth) <input type="checkbox"/> 40" (24" Seat Depth)	<input type="checkbox"/> 34" <input type="checkbox"/> 36" <input type="checkbox"/> 38"
 <ul style="list-style-type: none"> <input type="checkbox"/> #22 - 60" Small Sofa + Arms 	<input type="checkbox"/> 36" (22" Seat Depth) <input type="checkbox"/> 38" (23" Seat Depth) <input type="checkbox"/> 40" (24" Seat Depth)	<input type="checkbox"/> 34" <input type="checkbox"/> 36" <input type="checkbox"/> 38"
 <ul style="list-style-type: none"> <input type="checkbox"/> #30 - 81" Sofa + Arms 	<input type="checkbox"/> 36" (22" Seat Depth) <input type="checkbox"/> 38" (23" Seat Depth) <input type="checkbox"/> 40" (24" Seat Depth)	<input type="checkbox"/> 34" <input type="checkbox"/> 36" <input type="checkbox"/> 38"
 <ul style="list-style-type: none"> <input type="checkbox"/> Sectional 	SELECT SECTIONAL PIECES AT STEP 8.	

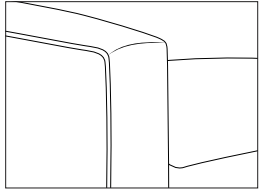
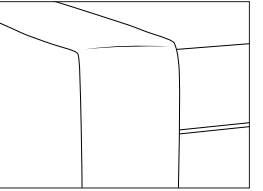
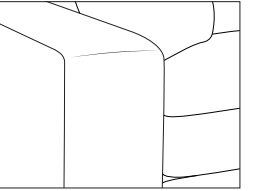
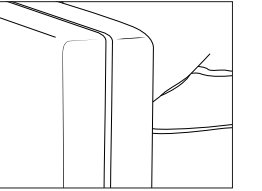
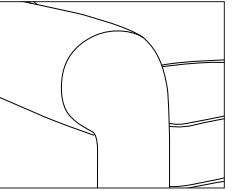
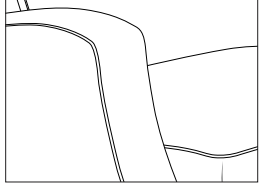
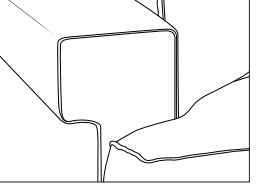
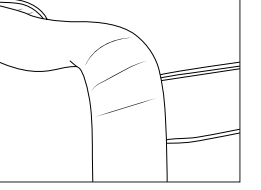
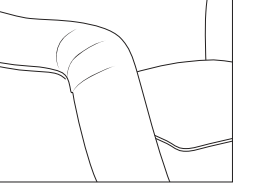
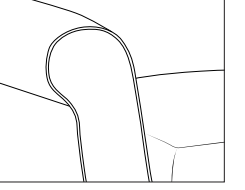
STEP 2: CHOOSE YOUR ARM

 <ul style="list-style-type: none"> <input type="checkbox"/> 4" Track Arm 24"H <input type="checkbox"/> NO WELT <input type="checkbox"/> 1/4" STANDARD WELT <input type="checkbox"/> 1/8" FINE WELT 	 <ul style="list-style-type: none"> <input type="checkbox"/> 6" Track Arm 24"H <input type="checkbox"/> NO WELT <input type="checkbox"/> 1/4" STANDARD WELT <input type="checkbox"/> 1/8" FINE WELT 	 <ul style="list-style-type: none"> <input type="checkbox"/> 9" Track Arm 24"H <input type="checkbox"/> NO WELT <input type="checkbox"/> 1/4" STANDARD WELT <input type="checkbox"/> 1/8" FINE WELT 	 <ul style="list-style-type: none"> <input type="checkbox"/> 6" Split Track 26"H INCLUDES 1/4" STANDARD WELT 	 <ul style="list-style-type: none"> <input type="checkbox"/> 8" Sock Arm 26"H <input type="checkbox"/> NO WELT <input type="checkbox"/> 1/4" STANDARD WELT <input type="checkbox"/> 1/8" FINE WELT
 <ul style="list-style-type: none"> <input type="checkbox"/> 4.5" Deco Arm 24"H <input type="checkbox"/> NO WELT <input type="checkbox"/> 1/4" STANDARD WELT <input type="checkbox"/> 1/8" FINE WELT 	 <ul style="list-style-type: none"> <input type="checkbox"/> 6" Grand Arm 24"H <input type="checkbox"/> NO WELT <input type="checkbox"/> 1/4" STANDARD WELT <input type="checkbox"/> 1/8" FINE WELT 	 <ul style="list-style-type: none"> <input type="checkbox"/> 6" English Arm 26"H <input type="checkbox"/> NO WELT <input type="checkbox"/> 1/4" STANDARD WELT <input type="checkbox"/> 1/8" FINE WELT 	 <ul style="list-style-type: none"> <input type="checkbox"/> 6" Bentley Arm 24"H <input type="checkbox"/> NO WELT <input type="checkbox"/> 1/4" STANDARD WELT <input type="checkbox"/> 1/8" FINE WELT 	 <ul style="list-style-type: none"> <input type="checkbox"/> 6" Dorset Arm 24"H <input type="checkbox"/> NO WELT <input type="checkbox"/> 1/4" STANDARD WELT <input type="checkbox"/> 1/8" FINE WELT

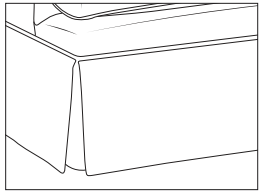
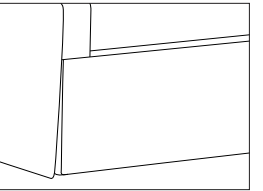
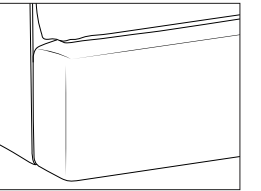
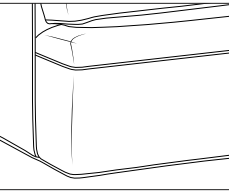
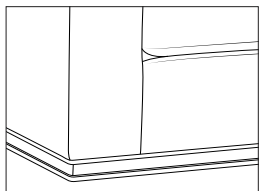
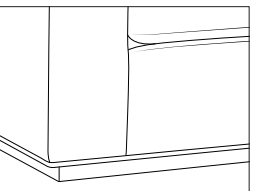
STEP 3: CHOOSE YOUR BASE

 <ul style="list-style-type: none"> <input type="checkbox"/> T-Flounce Hidden Leg* 	 <ul style="list-style-type: none"> <input type="checkbox"/> S-Flounce Hidden Leg* 	 <ul style="list-style-type: none"> <input type="checkbox"/> Plain Hidden Leg* 	 <ul style="list-style-type: none"> <input type="checkbox"/> Banded Hidden Leg*
 <ul style="list-style-type: none"> <input type="checkbox"/> Molded Wood Base UPCHARGE 	 <ul style="list-style-type: none"> <input type="checkbox"/> Wood Plinth Base UPCHARGE 	 <ul style="list-style-type: none"> <input type="checkbox"/> Plain Exposed Leg** 	 <ul style="list-style-type: none"> <input type="checkbox"/> Banded Exposed Leg**

*Hidden leg finish is Caramel.

**Choose leg and wood finish at step 7. Base is shortened proportionally to exposed leg height.

STEP 4: CHOOSE YOUR SEAT SHAPE & SEAT FILL

SEAT SHAPE

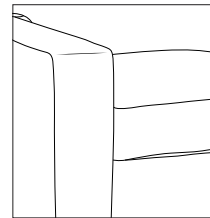
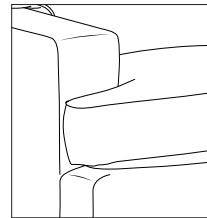

T-Cushion

- NO WELT
- 1/4" STANDARD WELT
- 1/8" FINE WELT

Square Cushion

- NO WELT
- 1/4" STANDARD WELT
- 1/8" FINE WELT

SEAT FILL

- Cloud 9 (Standard Fill)**
High density foam core, wrapped in two layers of polyester fiber for softness and bounce, encased in ticking for strength and durability. This is our most popular seat cushion.
- Luxe Aire (Standard Fill)**
Premium polyurethane foam wrapped in D91 polyester fiber and encased in ticking. This is a firm seat with minimum crown ensuring comfort and durability.
- Down Supreme (Upcharge)**
High density foam interior encased in a 100% cotton down proof ticking envelope, of 90% feather and 10% down.
- Spring Down (Upcharge)**
High density foam interior surrounding a spring system, encased in a 100% cotton down proof ticking envelope, of 90% feather and 10% down.
- Trillum (Upcharge)**
High density foam core, encased in a 100% blown polyester fiber filled 100% cotton, channeled down proof cover. This option creates a very plush cushion that has a down like quality.

STEP 5: CHOOSE YOUR BACK SHAPE & BACK FILL

BACK SHAPE

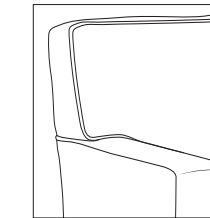
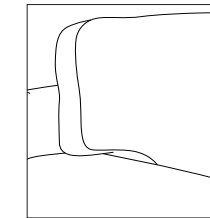
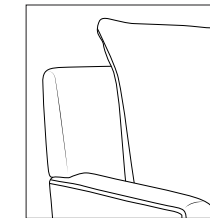
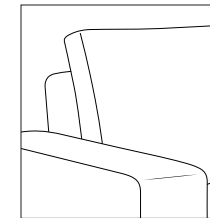

Square Boxed

- NO WELT
- 1/4" STANDARD WELT
- 1/8" FINE WELT

Knife Edge

- NO WELT
- 1/4" STANDARD WELT
- 1/8" FINE WELT

T-Boxed

- NO WELT
- 1/4" STANDARD WELT
- 1/8" FINE WELT

Tight Boxed

- NO WELT
- 1/4" STANDARD WELT
- 1/8" FINE WELT

BACK FILL

- Blend Down (Standard Fill)**
50% blown poly fiber, 45% feather, and 5% down channeled in a 100% cotton down proof ticking. This is our most popular back cushion.
- Regalaire (Standard Fill)**
Polyester fiber channeled inside a nonwoven casing. This choice offers a firm but soft back cushion that requires some fluffing.
- Down Supreme (Upcharge)**
90% feather, 10% down channeled in a 100% cotton down proof ticking.
- Trillum (Upcharge)**
100% blown polyester fiber encased in a 100% cotton, channeled down proof cover. This soft, plush back cushion has a down like quality.

STEP 6: CHOOSE YOUR FABRIC

Any fabric from our Burton James collection can be used. Refer to price list for pricing.

PATTERN: _____

COLOR: _____



STEP 7: ADD YOUR FINISHING TOUCHES

Select additional options: exposed legs, wood leg/base finish, nailheads, and welting.

EXPOSED LEG SHOWN IN CARAMEL



- A - Wood
5"W x 2"H
- B - Wood
6.5"W x 2"H
- D - Wood
5.75"W x 3"H
- E - Wood
5.75"W x 3"H
- F - Wood
6"W x 3"H
- H - Wood
2.75"W x 3.5"H



- J - Wood
3"W x 6"H
- L - Wood
3"W x 6"H
- K - Acrylic
3.5"W x 5.5"H

UPCHARGE

CASTERS

- None
- Hidden

WOOD LEG AND BASE FINISH PICK ONE | HIDDEN LEG FINISH IS CARAMEL

Standard Wood Finishes



- CREAM
- MILK
- CLOUD
- NATURAL
- SANDALWOOD
- CARAMEL



- FRENCH WALNUT
- OLD OAK
- UMBER
- DRIFTWOOD
- SHADOW
- BLACK WALNUT

Premium Wood Finishes UPCHARGE



- LINEN
- PEARL
- SAND
- ASH
- PUTTY
- SLATE



- SHALE
- CAVALIER
- RUSTIC GRAY
- REGENT
- ZEBRA
- BLACK LACQUER

NAILHEADS UPCHARGE | STANDARD DOES NOT INCLUDE NAILHEADS

Nailhead Size SHOWN TO SCALE | PICK ONE

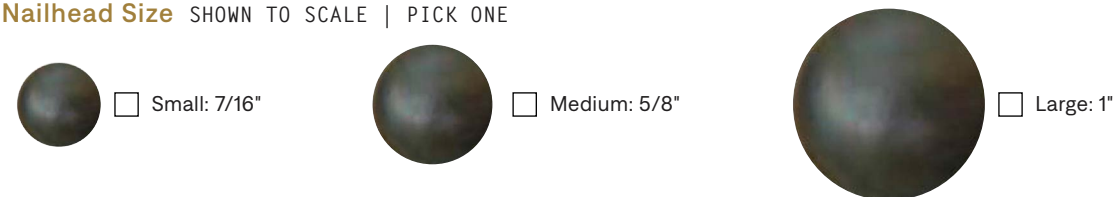

Nailhead Finish 7/16" SHOWN | PICK ONE

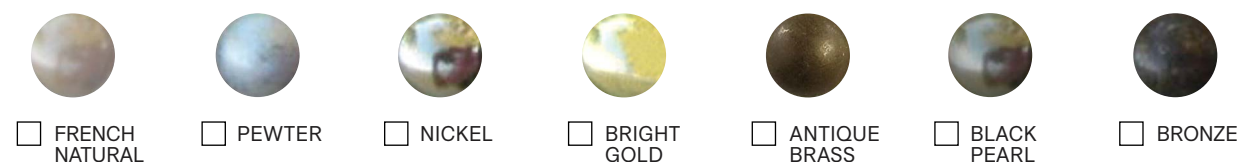

Nailhead Spacing

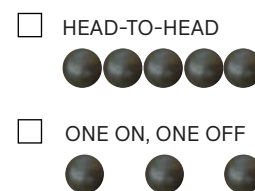

Nailhead Location

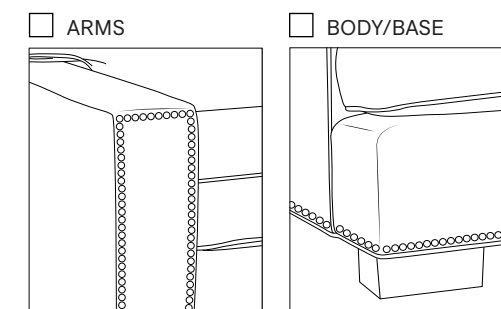

CONTRAST WELTING UPCHARGE

Welt Type + Location

- 1/4" CONTRAST WELT
- 1/8" CONTRAST WELT
- ARM
- SEAT/BACK CUSHION
- FABRIC PATTERN: _____
- COLOR: _____
- ARM
- SEAT/BACK CUSHION
- FABRIC PATTERN: _____
- COLOR: _____

Images are representations only. For true match please refer to physical samples.
Premium finishes, nailheads & acrylic leg(s) subject to additional charge.

STEP 8: CHOOSE YOUR SECTIONAL PIECES

- OVERALL DEPTH**
- 36" (22" Seat Depth)
 - 38" (23" Seat Depth)
 - 40" (24" Seat Depth)

- OVERALL HEIGHT**
- 34"
 - 36"
 - 38"



SOFAS/CHAIR

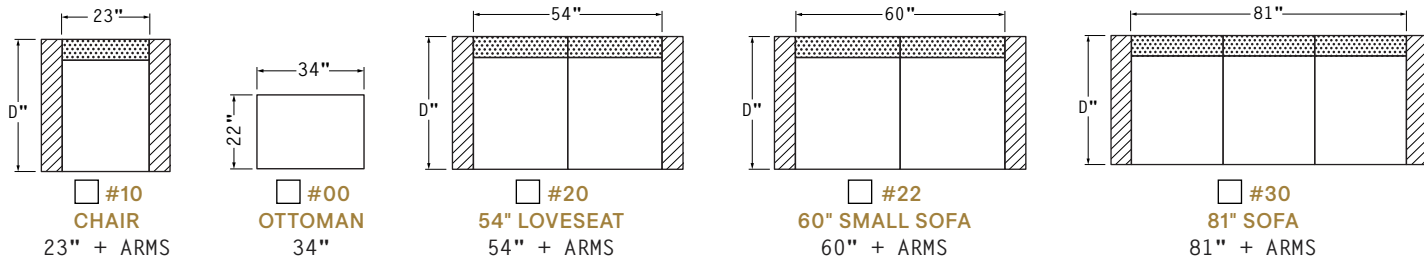

RIGHT ARM

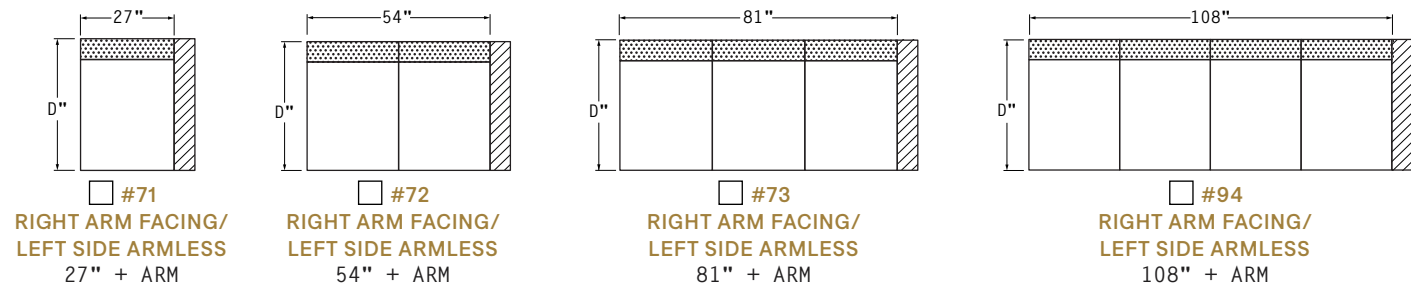

LEFT ARM

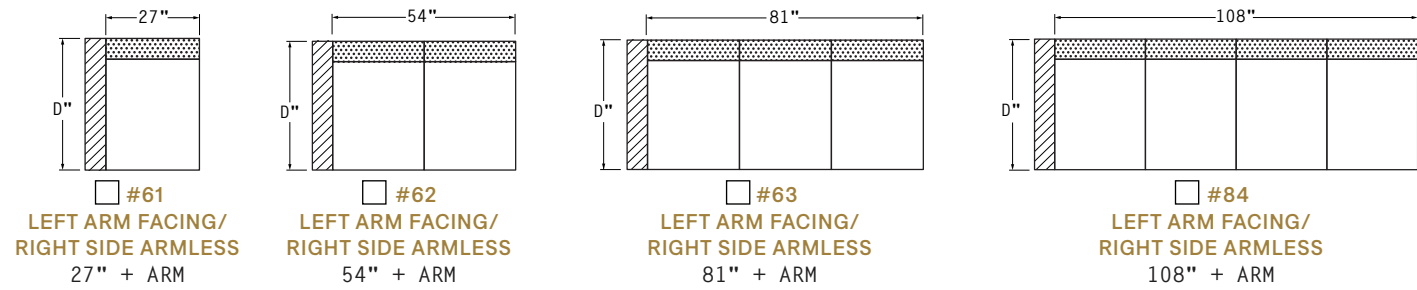

ARMLESS

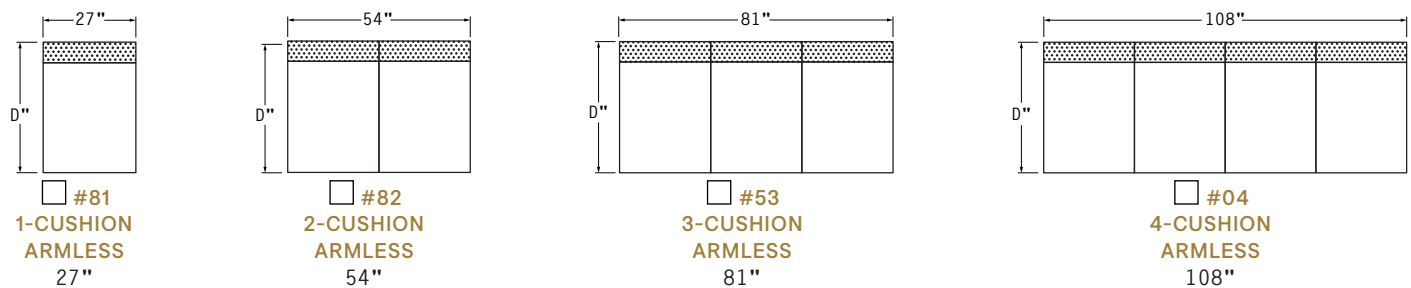

CORNER/RIGHT ARM

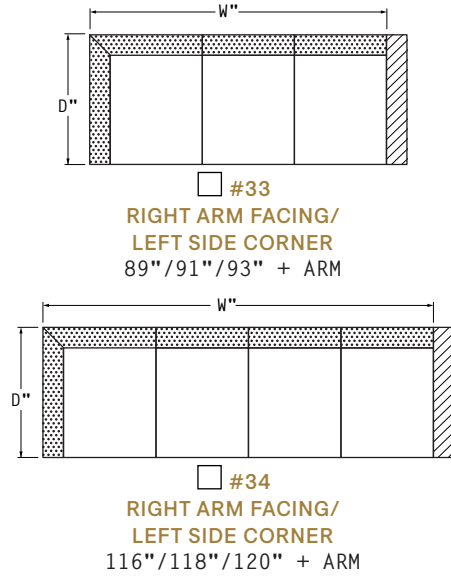

CORNER/LEFT ARM

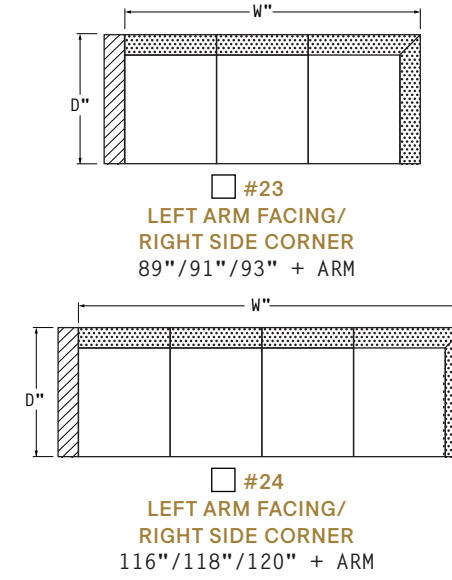

CORNERS

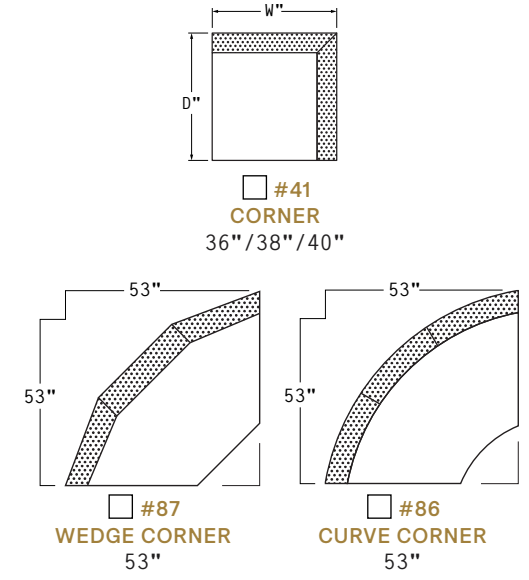

CHAISE/LEFT ARM

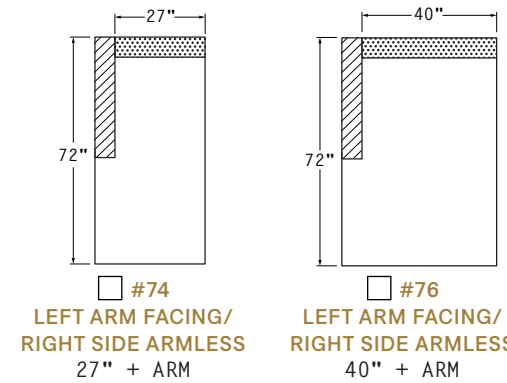

CHAISE/RIGHT ARM

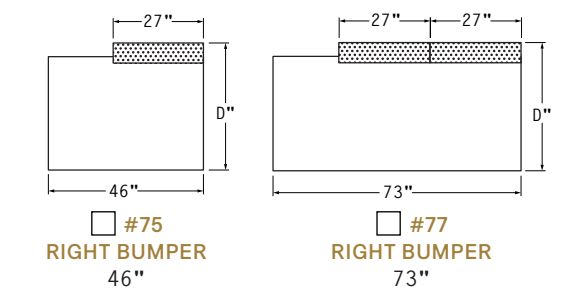
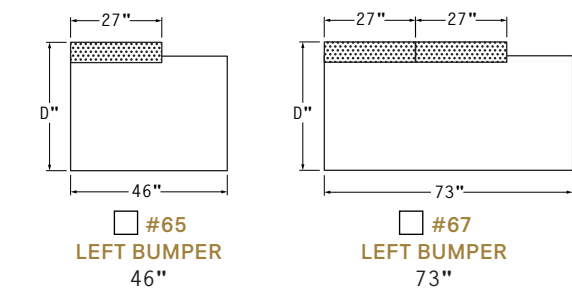
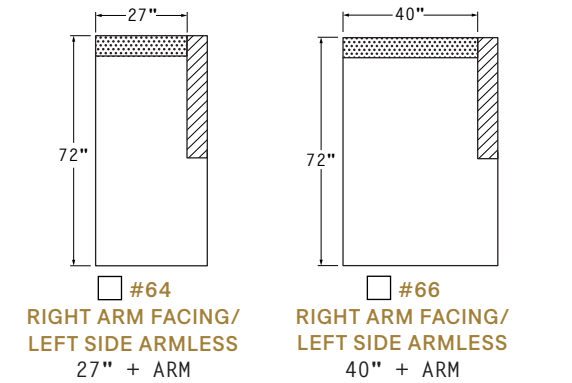

CORNERS/ARMS

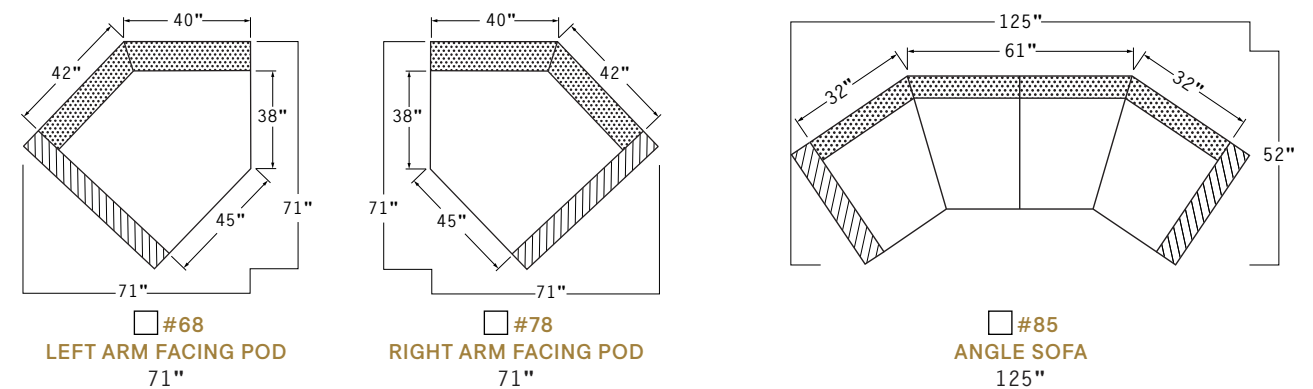

NOTES



BURTON JAMES

burtonjames.com · 626 961 7221 · info@burtonjames.com